



System Classic
AW.10.17



Gedvydžių g. 17A, LT-06311 Vilnius
Tel. +370 5 2761885
Vilnius@ometal.it

Ramygalos 137F, LT-36220 Panevėžys
Tel.: +370 45 58 66 61
Info@ometal.it

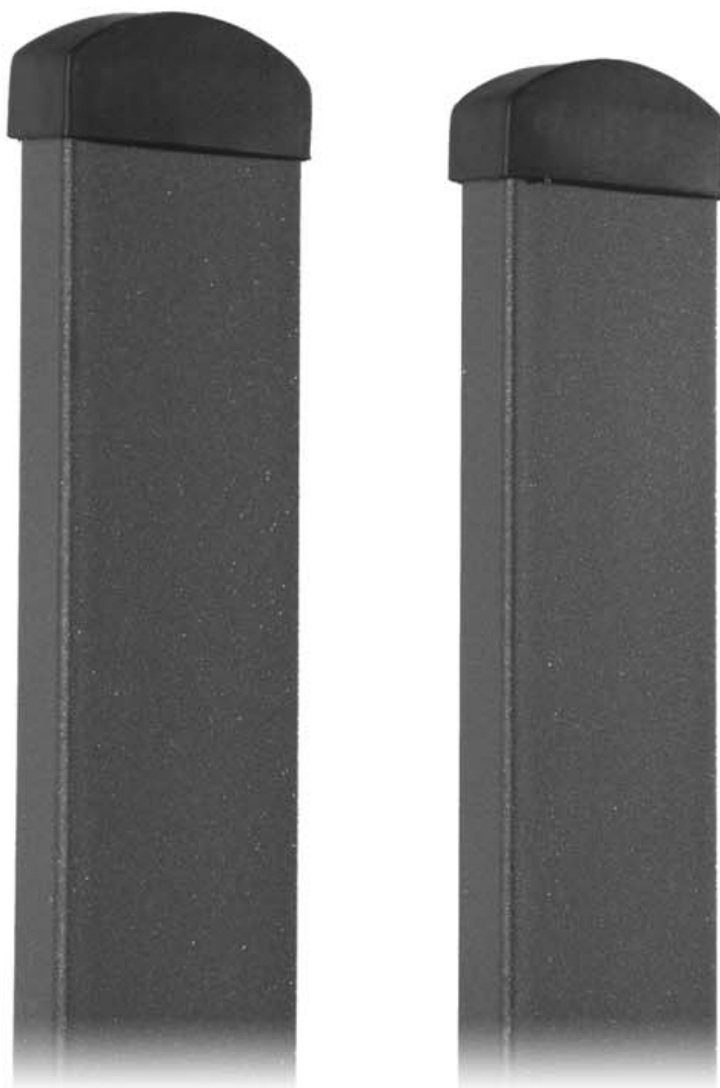

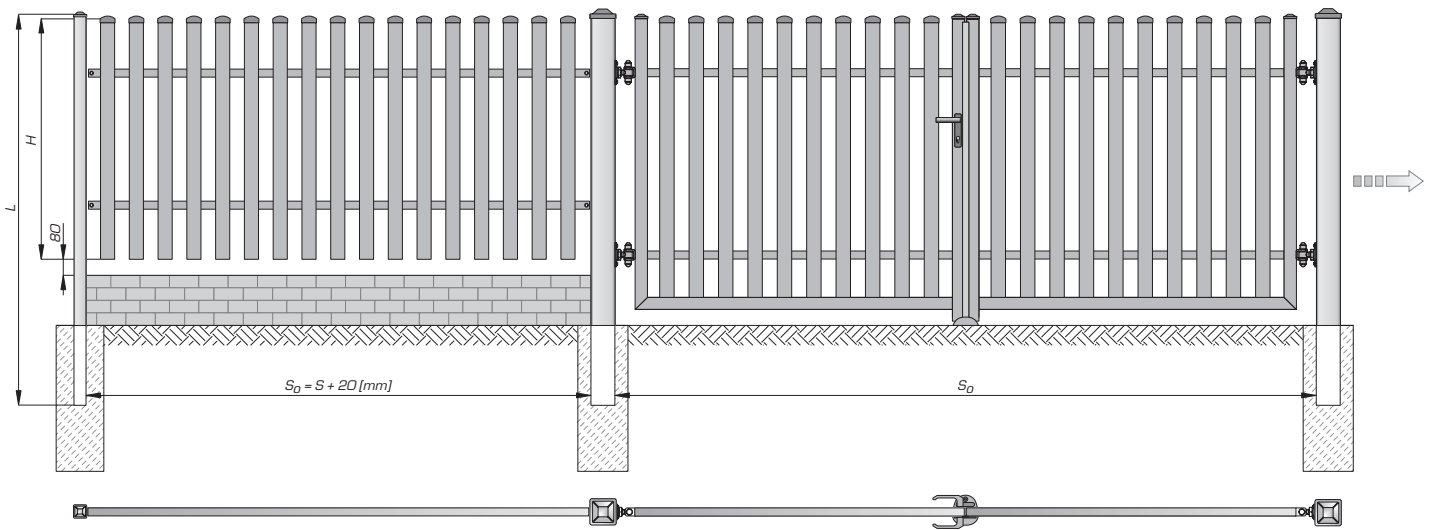
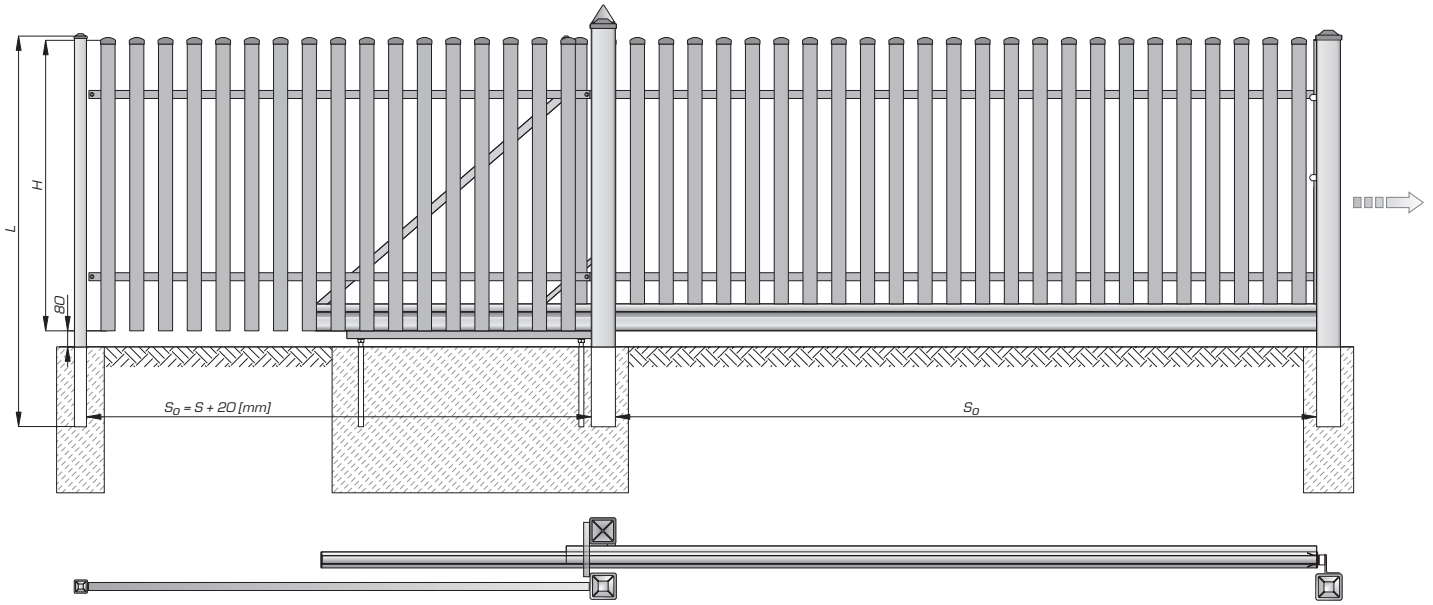

AW.10.17/P

(S) 2500 [mm] x (H) 900 [mm] - 40 kg	(S) 3000 [mm] x (H) 1200 [mm] - 56 kg
(S) 2500 [mm] x (H) 1200 [mm] - 47 kg	(S) 3000 [mm] x (H) 1450 [mm] - 66 kg
(S) 2500 [mm] x (H) 1450 [mm] - 54 kg	
max: (S) 3000 [mm] x (H) 1750 [mm]	

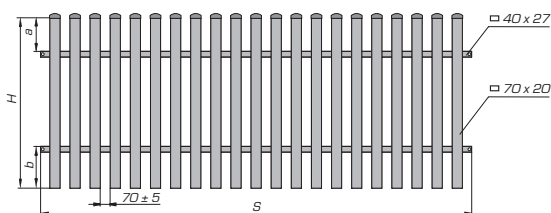

$H \geq 1000$: $a=250$, $b=300$, $H_{min}=800$ $800 \leq H < 1000$: $a=250$, $b=200$, $H_{min}=800$

AW.10.17/Wp

(S) 2500 [mm] x (H) 900 [mm] - 38 kg	(S) 3000 [mm] x (H) 1200 [mm] - 54 kg
(S) 2500 [mm] x (H) 1200 [mm] - 45 kg	(S) 3000 [mm] x (H) 1450 [mm] - 64 kg
(S) 2500 [mm] x (H) 1450 [mm] - 52 kg	
max: (S) 3000 [mm] x (H) 1750 [mm]	

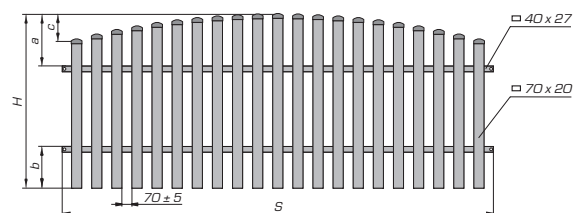

$H \geq 1100$: $a=350$, $b=300$, $c=175$, $H_{min}=900$ $900 \leq H < 1100$: $a=350$, $b=200$, $c=175$, $H_{min}=900$

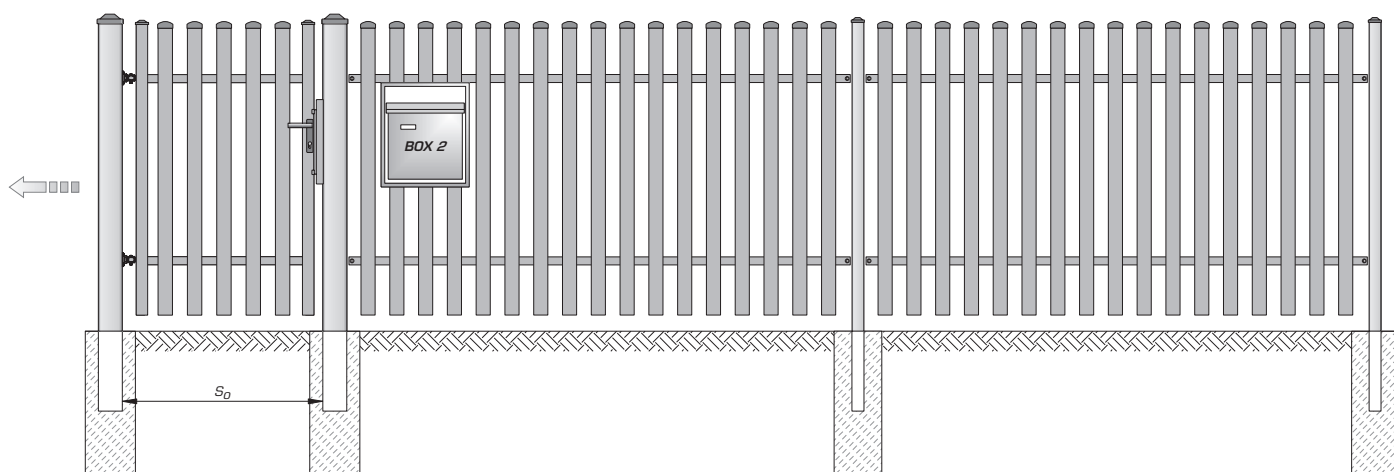
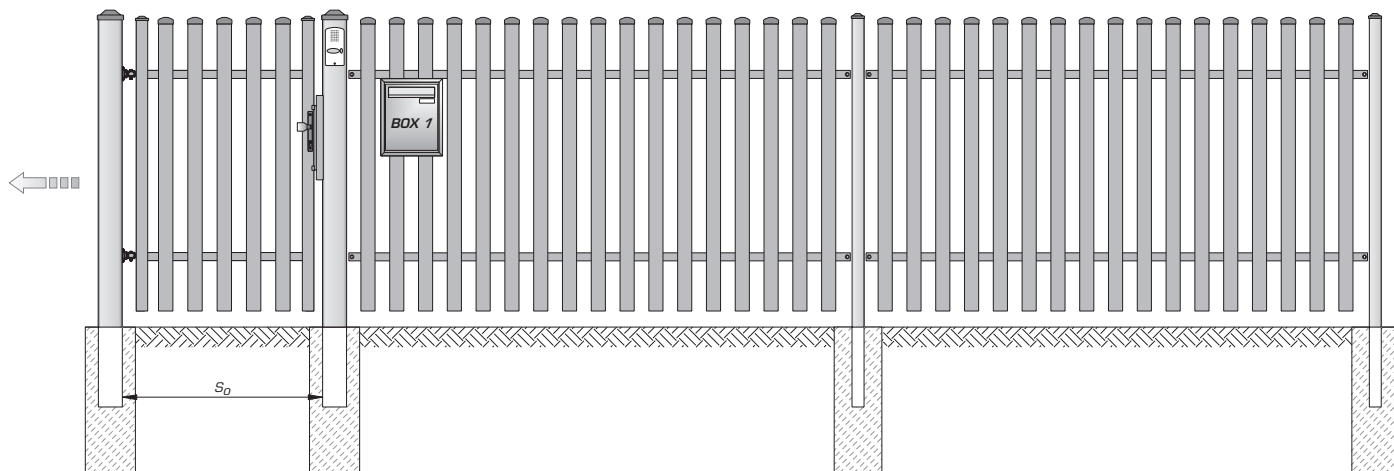

AW.10.17/Wk

(S) 2500 [mm] x (H) 900 [mm] - 38 kg	(S) 3000 [mm] x (H) 1200 [mm] - 54 kg
(S) 2500 [mm] x (H) 1200 [mm] - 45 kg	(S) 3000 [mm] x (H) 1450 [mm] - 64 kg
(S) 2500 [mm] x (H) 1450 [mm] - 52 kg	
max: (S) 3000 [mm] x (H) 1750 [mm]	

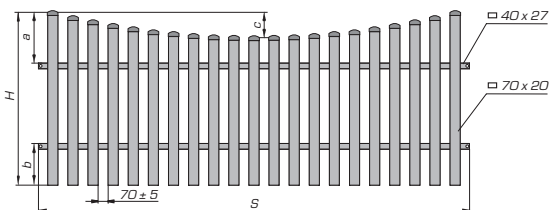

$H \geq 1100$: $a=350$, $b=300$, $c=175$, $H_{min}=900$ $900 \leq H < 1100$: $a=350$, $b=200$, $c=175$, $H_{min}=900$

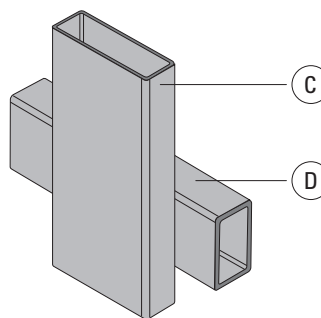

U1 C 70x20 D 40x27